

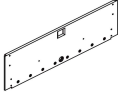

05802

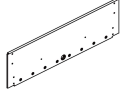



	OLDAL LEMEZ
1 x	
05-802G-01	

	OLDAL LEMEZ
1 x	
05-802G-02	

	ZÁRÓ LEMEZ
1 x	
05-802G-03	

	ZÁRÓ LEMEZ
1 x	
05-802G-04	

	LÁB PANEL
2 x	
05-802G-05	

	JÁTÉKTÉR
1 x	
05-802G-06	

	JOBBS LÁB
2 x	
05-802G-07	

	BAL LÁB
2 x	
05-802G-08	

	SAROK VÉDŐ
4 x	
05-802G-09	

	MARKOLAT
8 x	
05-802G-10	

	BIZTONSÁGI ZÁRÓDUGÓ
8 x	
05-802G-11	

	CSÚSZKÁS EREDMÉNYJELZŐ
2 x	
05-802G-12	

	KERESZT MEREVÍTŐRÚD
2 x	
05-802G-13	

	LÁBDABEMENET
2 x	
05-802G-14	

	BT modul
1 x	
05-802G-15	

	LÁBKIEGYENLÍTŐ
4 x	
05-802G-16	

	Eszköztartó
1 x	
05-802G-17	

	CSAVAR
4 x	
05-802G-18	

	CSAVAR
22 x	
05-802G-19	

	CSAVAR
16 x	
05-802G-20	

	ALÁTÉT
24 x	
05-802G-21	

	ANYACSAVAR
4 x	
05-802G-22	

	CSAVAR
2 x	
05-802G-23	

	CSAVAR
8 x	
05-802G-24	

05802

carromco

	FOCILABDA
2 x	
05-802G-25	

	FOCILABDA
2 x	
05-802G-26	

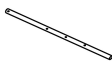
	3 LYUKÚ ÜREGES JÁTÉKOS RÚD
4 x	
05-802G-27	

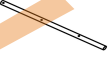
	2 LYUKÚ ÜREGES JÁTÉKOS RÚD
2 x	
05-802G-28	

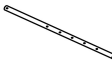
	5 LYUKÚ ÜREGES JÁTÉKOS RÚD
2 x	
05-802G-29	

	JÁTÉKOS - "A" CSAPAT
11 x	
05-802G-30	

	JÁTÉKOS - "B" CSAPAT
11 x	
05-802G-31	

	JÁTÉKOST RÖGZÍTŐ CSAVAR
26 x	
05-802G-32	

	JÁTÉKOST RÖGZÍTŐ ANYACSAVAR
22 x	
05-802G-33	

	JÁTÉKOS FÉKEZŐGYŰRŰ
4 x	
05-802G-34	

	ANYACSAVAR
4 x	
05-802G-35	

	GUMI ÜTKÖZŐ
16 x	
05-802G-36	

	IMBUSZ KULCS
1 x	
05-802G-37	

	IMBUSZ KULCS
1 x	
05-802G-38	

	LABDA-VISSZAVEZETŐ DOBOZ
2 x	
05-802G-39	

	CSAVAR
8 x	
05-802G-40	

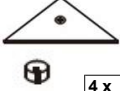
	SAROK & FEDÉL
4 x	
05-802G-41	











	CSAVAR
4 x	
05-802G-42	

FIG. 1

#01		1 x	#03		1 x	#04		1 x
#24		4 x	#21		4 x	#19		8 x
						#39		2 x

**FIG. 2**

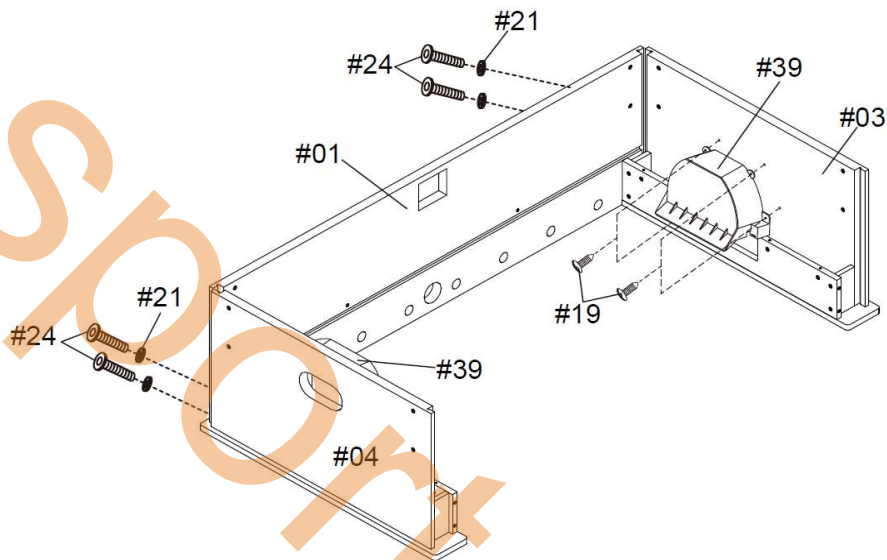
#06		1 x
-----	---	-----

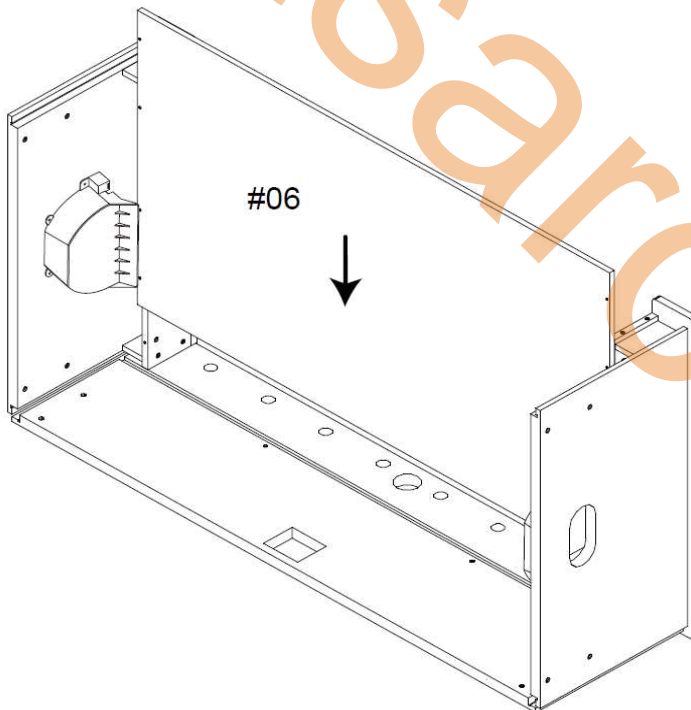



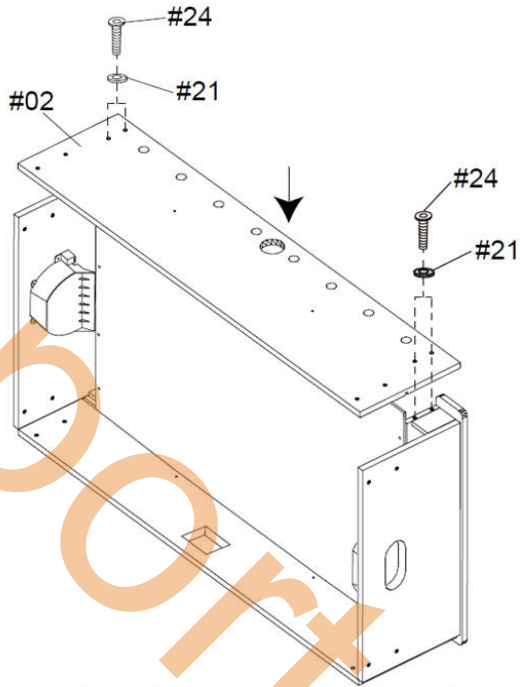
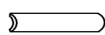



FIG. 3

#24		4 x	#21		4 x
			#02		1 x

**FIG. 4**

#09		4 x	#40		8 x
-----	---	-----	-----	---	-----

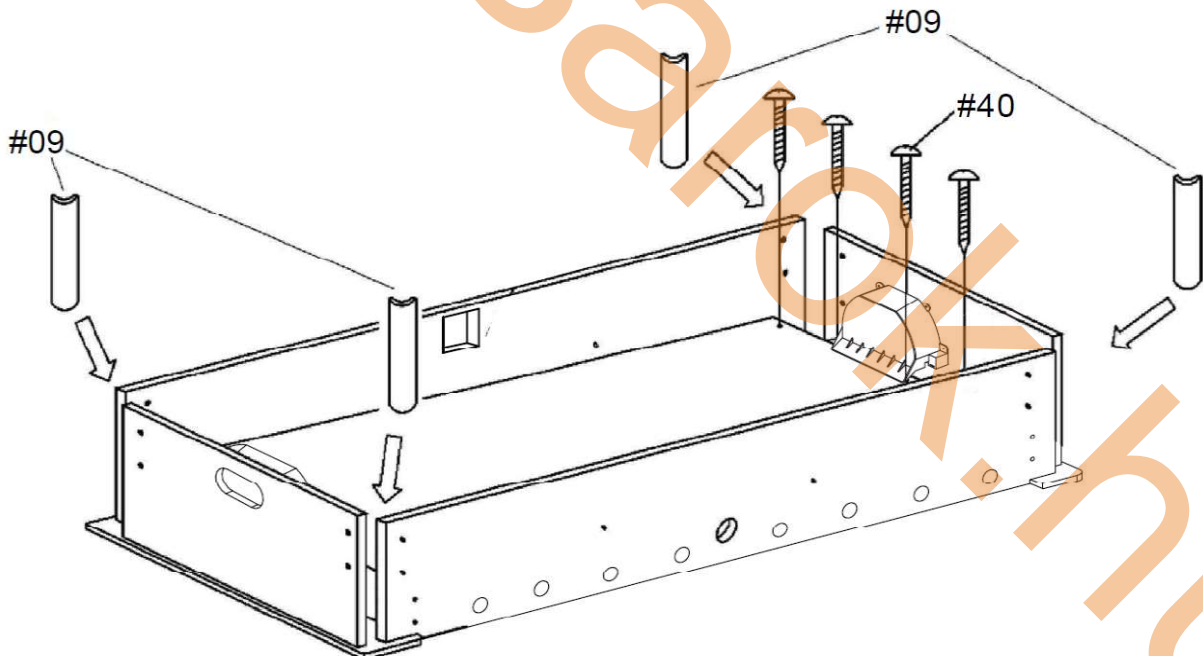

FIG. 5

#13		2 x	#22		4 x	#19		8 x
#37		1 x						

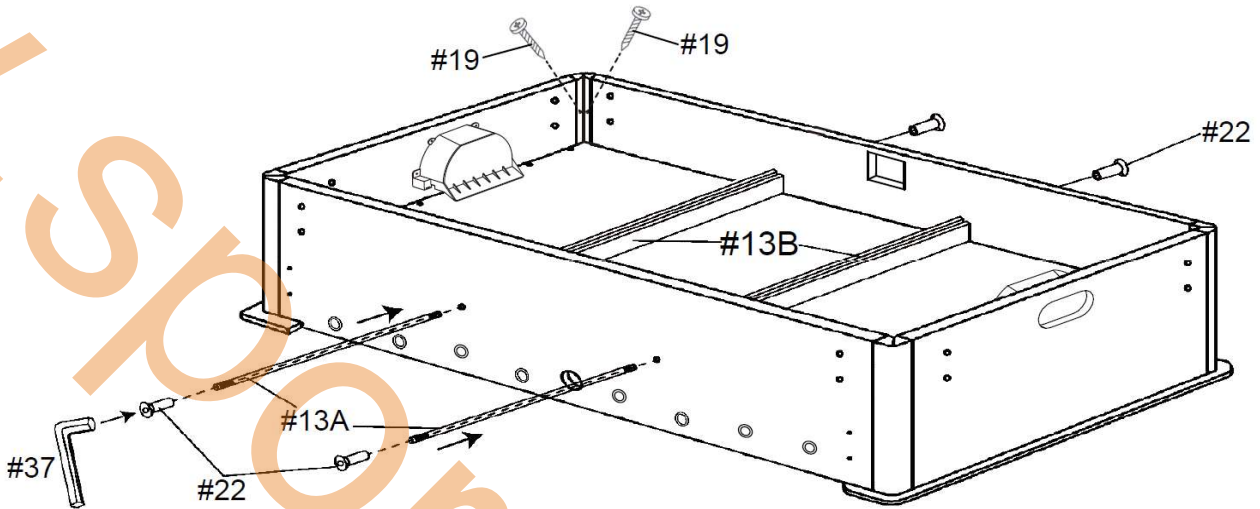

FIG. 6

#16		4 x	#07		2 x	#08		2 x
#20		16 x	#21		16 x	#05		2 x
						#37		1 x

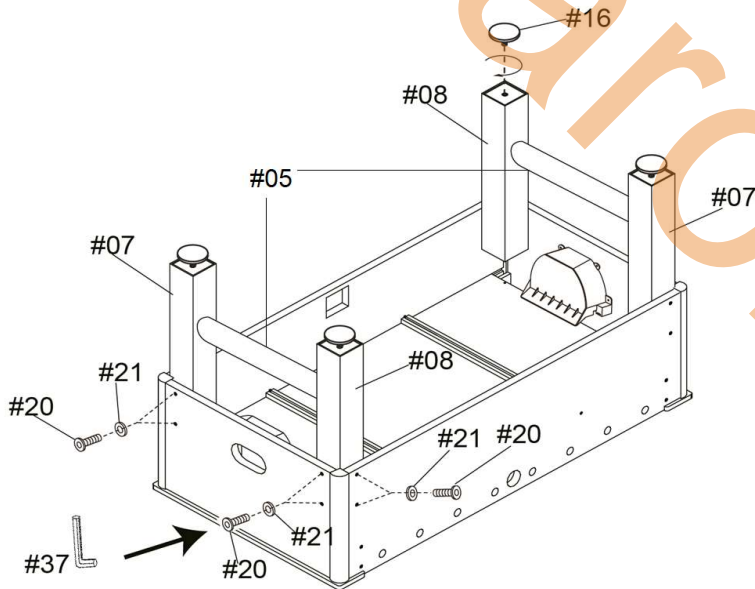

FIG. 7

#15



1 x #19





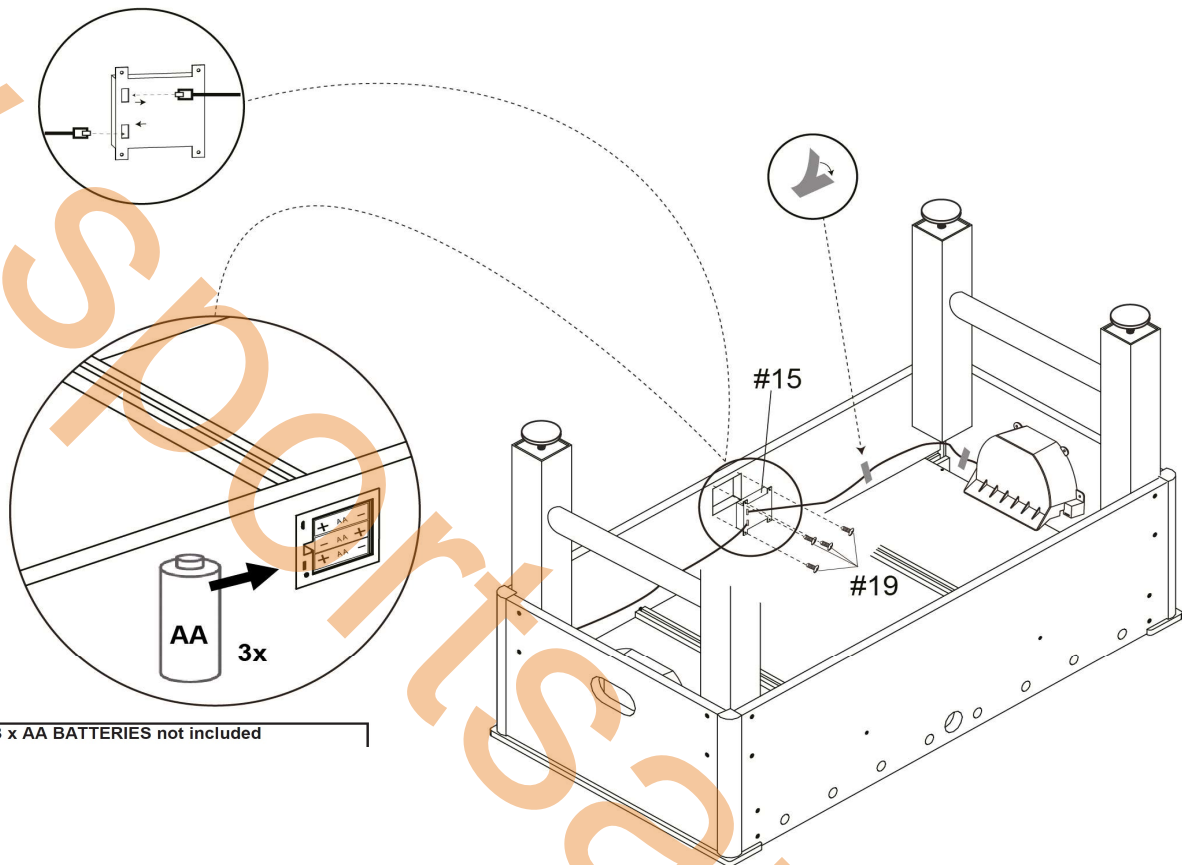

4 x



3 x AA BATTERIES not included

FIGYELEM! Különböző típusú akkumulátorokat vagy új és régi akkumulátorokat nem szabad összekeverni! A nem újratölthető elemeket nem szabad újratölteni. Az újratölthető akkumulátorokat töltés előtt ki kell venni. Az újratölthető akkumulátorokat csak felnőtt felügyelete mellett szabad feltölteni. A lemerült elemeket el kell távolítani a játékból. Az elemeket a megfelelő polaritással kell behelyezni. A tápcsatlakozókat nem szabad rövidre zárni.

FIGYELMEZTETÉS: A KÖVETKEZŐ LÉPÉSHEZ 2 FELNŐTTRE VAN SZÜKSÉG! NAGYON ÓVATOSAN ÁLLÍTSA FEL AZ ASZTALT A LÁBAIRA. VIGYÁZZON, AZ ASZTAL NEHÉZ. NE FOGJA AZ ASZTALT A LÁBAINÁL FOGVA, ÉS NE TÁMASSZA AZ ASZTALT A LÁBAIRA! NE EMElje FEL VAGY FORDÍTSA MEG AZ ASZTALT A RUDAK SEGÍTSÉGÉVEL, MERT EZ KÁROSÍTHATJA AZOKAT.

FIG. 8

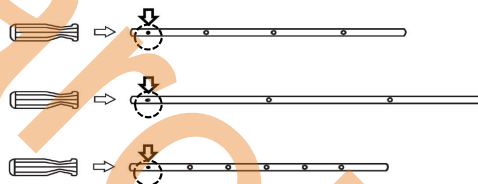
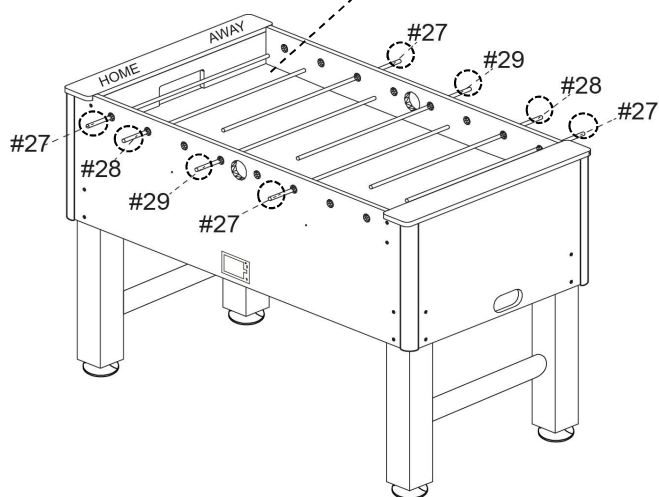
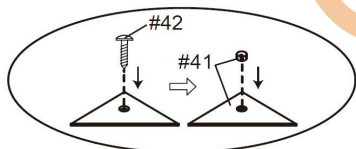
#27		4 x	#28		2 x	#29		2 x
			#41		4 x	#42		4 x

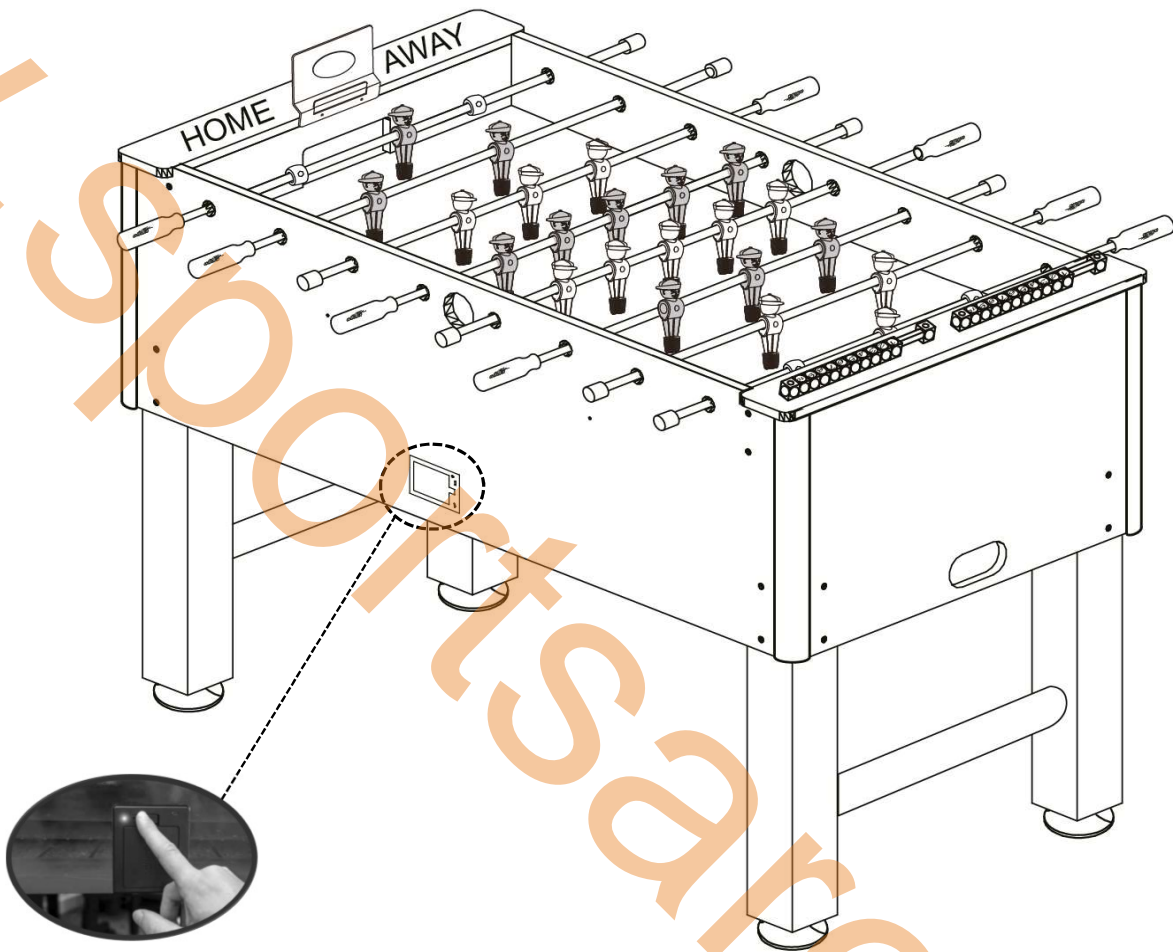

FIGYELEM: FIGYELJEN A RÚD EGYIK VÉGÉN LÉVŐ KIS JELŐLÉSRE. A MARKOLATOT EZEN AZ OLDALON KELL RÖGZÍTENI.

FIG. 11

!!! Ne felejtse el kikapcsolni a BI Boxot játék után, hogy megkímélje az akkumulátort.

